

F Series – Fluid Coils



www.Alcoil.net



For: Fluid Coolers
 Chilled Water Coils
 Hot Water Coils
 Special Fluids
 Gases

F Series – FLUID Coils

Alcoil Microchannel Features (F Series)

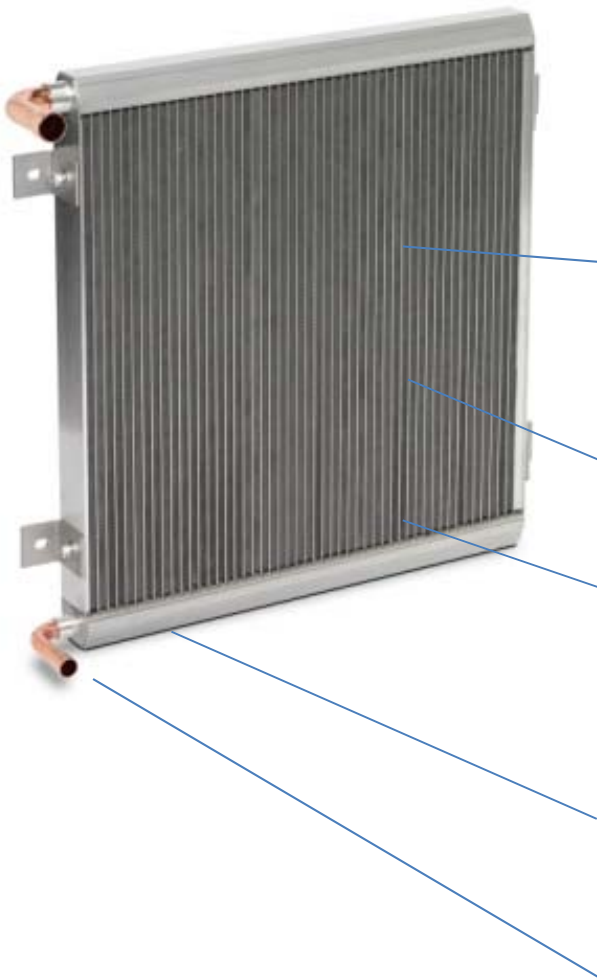

Custom & Standard Sizes

Flexibility and variable dimensions are tailored to our OEM customer needs using AlcoilSELECT Software. Custom and QuickShip sizes are available from as small as 4"x4" to over 80"x144". Capacities range from ¼ tons to over 30 tons.

Easy OEM Mounting

The coil itself is a robust frame that provides air tight flush mounting, thereby eliminating unnecessary components and air bypass. Optional "L" brackets, ¼"-20 studs or ¼"-20 flush nuts are available for easy mounting.

High Performance Fins

A state of the art louvered fin design provides low airside pressure drop and high heat transfer.

Vertical MicroChannel Tubes

Alcoil's patented innovation incorporates vertical tubes that enhance fluid heat transfer, ensure predictable performance and low pressure drop. Tube wall thickness are greater than most automotive and import microchannel designs to assure long life operation.

Low Pressure Drop Headers

Unlike any HVAC/R coil, all Alcoil units have ultra low pressure drop in the headers. This unique feature allows the coil to perform well many demanding applications.

Connections and More

Alcoil heat exchangers are available with MPT connections, copper sweat connections and custom orientations.

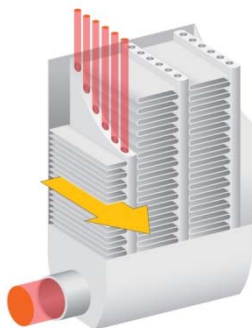

Alcoil's MicroChannel Coils are based on a "Next Generation" design that combines high performance flat tubes, state of the art airside fins and low PD headers. The tubes have numerous mini-ports that enhance fluid side performance, while the Airside achieves closer approach temperatures and lower airside pressure drops. The end result is higher overall heat transfer performance,

Typical Configurations

Alcoil's F Series is a multi-purpose coil designed for fluid to air applications, dry coolers, chilled water coils, heating coils, flooded and pumped loop evaporators, gas cooling/heating, special fluid heating/cooling and other applications. It is available as a 1.25V model and 1.25LV extra large header version. These two versions can be configured as F, 2F and 3F sizes.

The F Series differs from the C (condenser) and B Series in that it has full flow pass-through and has application versatility in Medium to High Fluid flow rate applications. Designed with Alcoil's 1.25F low pressure drop tube, the F Series has high performance, while rated at 300psig working pressure.

F Models

F Models are Single "Module" models.



F Model
w/ Elbow Connections at 3 o'clock
w/ LBrackets

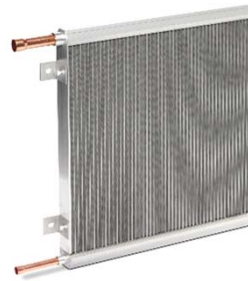

w/ Straight Connections
w/ LBrackets

2F & 3F Models

"Multi-Module" versions are designated as 2F & 3F models. These models are typical for larger capacity coils and specialty coils, depending on actual design conditions, type refrigerant or gas, air flow rate and target performance.

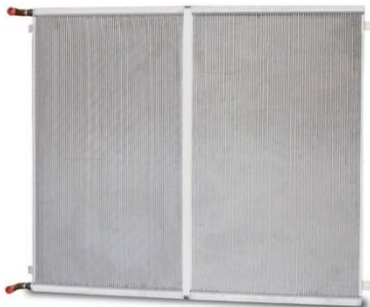

2F Model
w/ Elbow Connections
w/ LBrackets



3F Model
w/ Elbow Connections
w/ LBrackets

F Series – Multi-Purpose Fluid Coil

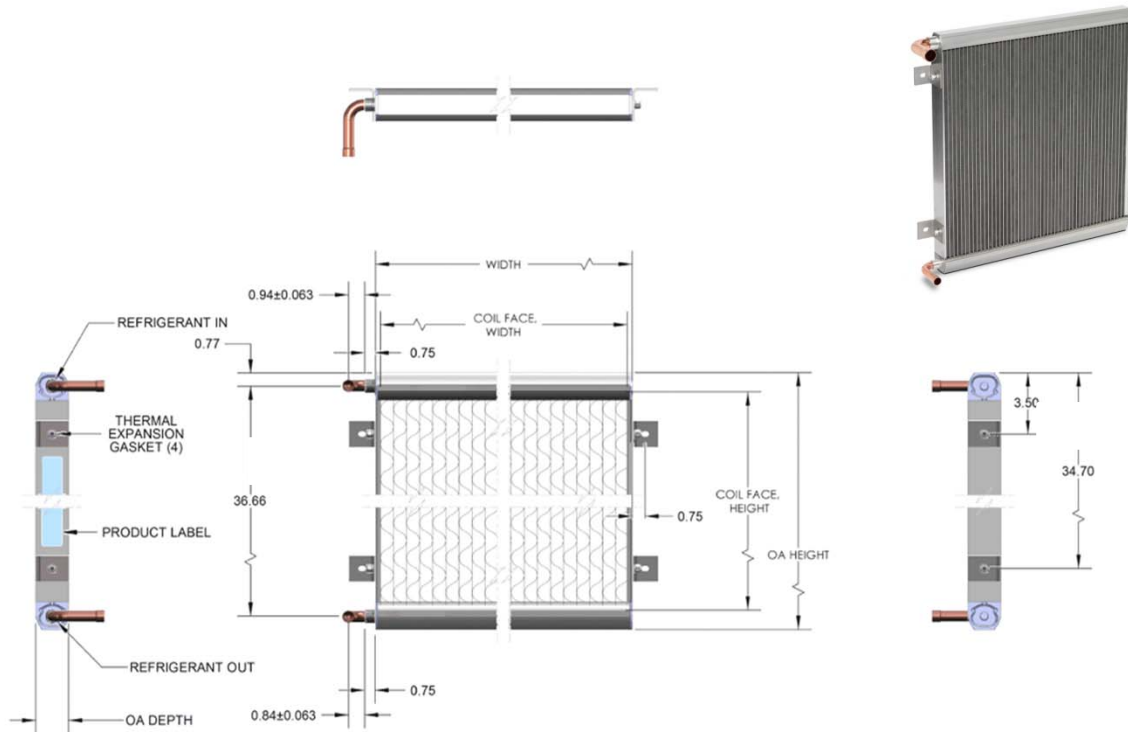

Fluid & Gases	Water, Glycols, Oils, N ₂ , He, Ar, and other Gases R134a and other low pressure refrigerants		
Design Working Pressure	<u>300psig</u>		
Design Working Temperature	250F		
Maximum Face Width (F model)	46.4"		
Maximum Face Width (3F model)	138" (up to 188")		
Maximum Face Height	77" (up to 96" upon request)		
Tube Size	1.25F" (Fluid)		<u>1.9" O.A. Depth</u>
Fins	24 fpi, high performance, louvered 10 fpi, low PD (optional)		
Connection Sizes	(1.25V model)	3/4" & 1" MPT, Aluminum 3/8", 1/2", 5/8", 7/8", 1-1/8" IDS Copper	<u>Max 15 gpm</u>
	(1.25LV model)	1" & 1-1/2" MPT, Aluminum 1-5/8" ODS Copper	<u>Max 50 gpm</u>
Mounting	LBrackets, 1/4"-20 x 1/2" Studs, or 1/4"-20 Female Flush Nuts		
Testing	Per UL 207 at full pressure, Helium Leak tested		

Model Nomenclature **F24x36x1.25V-15H11-K2199C-01**

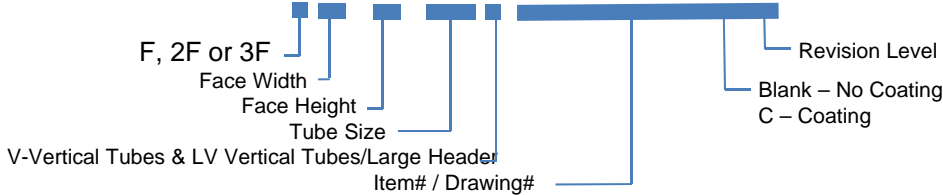

Connection Options

All F Series coils have options for EndCap connections for easy packaging, piping and fit-up. Standard MPT, Male Pipe Thread connections are available and including copper connections shown below. All connections options are available using AlcoilSELECT™ software.

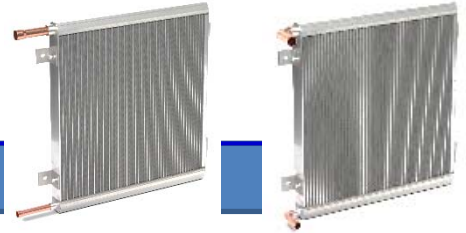

► EndCap Connections

1.25V Models 3/4" Aluminum MPT, & 1" Aluminum MPT, 3/8", 1/2", 5/8", 7/8", & 1-1/8" IDS Copper ,
 1.25LV Models 1" Aluminum MPT, & 1-1/2" Aluminum MPT, 1-5/8 ODS Copper ,

Location

Same Side Connections (std)
 Opposite Side Connections

Std

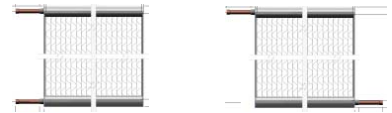

Straight Copper Copper Elbow

Same Side Connections (std)
 Same Side Connections (std)
 3 o'clock, 6 o'clock, 9 o'clock, 12 o'clock
 Opposite Side Connections
 Custom angles (w/ volume production)

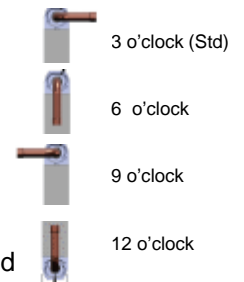

Aluminum MPT

Same Side Connections (std)

Specials

1.25V – 3/4" & 1" Stainless Steel or Carbon Steel Pipe, Butt Weld
 1.25LV – 1" & 1-1/2" Stainless Steel or Carbon Steel Pipe, Butt Weld

► Face Connections

Face Connections are ideal for compact packaging where dimensions and space are critical. Standard location is Left side on the headers. Optional locations are header center or right side of headers. Straight and elbow connections, up to 7/8" IDS are available.

1.25V Models 3/8", 1/2", 5/8", 7/8" ID Solder
 1.25LV Models Not available



Location

Left, Same Side (std),
 Center
 Right
 Opposite Sides, Left/Right, Right/Left

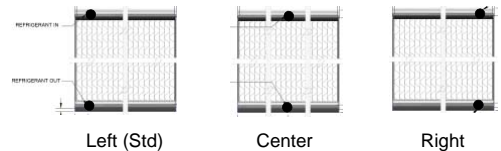

Copper Straight (Std) Copper Elbow

Same side (Std)
 3 o'clock, 6 o'clock, 9 o'clock, 12 o'clock
 Opposite Side Connections
 Custom angles (w/ volume production)

Aluminum MPT

Not Available

Specials

Not Available

Mounting Options

Alcoil models have four practical options for easy mounting and fit into OEM systems.

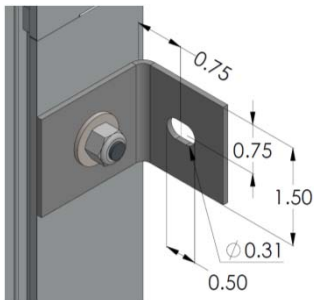

Mounting Bracket

1-1/2 x 1-1/2" with 3/4" L Stud & Nut
 2 Brackets, each side up to 53" models
 3 Brackets, each side & center for 54" and taller models
 Thermal expansion gaskets included, under bracket



1/4"-20 Threaded Flush Nut Insert

Located 3.5" from either end for compact mounting from side wall or strut, or use with customer supplied Bracket.
 2 inserts, each side up to 53" models
 3 inserts, each side & center for 54" and taller models
 5/16" maximum thread depth

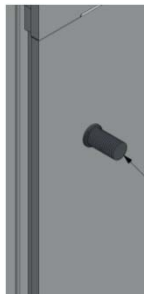

1/4"-20 Studs

Located 3/4"L, 3.5" from either end. For use with customer supplied Brackets or through-the-wall mounting.
 2 Studs, each side up to 53" models
 3 Studs, each side & center for 54" and taller models

None

Terms & Conditions



The following terms and conditions apply to all purchase orders, contracts or shipments between Alcoil ("Alcoil") and any customer ("Customer") for which Alcoil provides equipment, products, or services:

OFFER AND ACCEPTANCE. The products and services described are offered for sale by Alcoil subject to all of the terms and conditions stated herein. This writing constitutes an offer of sale, which is expressly limited to the products, services, terms, and conditions stated herein. By submitting a purchase order or other written response to this offer of sale, or by accepting delivery of the products and services offered herein, Customer accepts all of the terms and conditions contained herein. No additional, changed, or conflicting terms and conditions appearing in Customer's purchase order or other written response to this offer shall be binding upon Alcoil unless expressly agreed to in writing by Alcoil.

PAYMENT TERMS. Payment terms are NET 30 Days from Date of Invoice, Subject to credit approval by Alcoil's Credit Dept. Shipments, deliveries, and performance of work by Alcoil shall be subject to the continuing approval of Alcoil's Credit Dept., which may require full or partial payment in advance if the financial condition of Customer (in the sole opinion of Alcoil's Credit Dept.) does not justify continuance of work by Alcoil on the terms of payment agreed upon.

PRICES. All Prices are F.O.B, York, Pennsylvania, USA. All transportation expenses shall be paid by Customer, either Freight Collect, or Pre-paid/Add to Invoice. Alcoil reserves the right to adjust prices (surcharge or credit) at time of order entry due to material cost fluctuations.

TITLE AND RISK OF LOSS. Title to any products shipped by Alcoil shall pass to Customer upon delivery by Alcoil to the carrier. Risk of loss or damage to products in transit is assumed by Customer, and Customer shall bear responsibility for filing and pursuing any claims for loss or damage with the carrier.

DELIVERY. Shipping dates are approximate only based upon prompt receipt from Customer of all information required by Alcoil to meet Customer expectations. Alcoil shall not be liable for delays in delivery or failure to perform hereunder where such delay or failure results from: (i) causes beyond the reasonable control of Alcoil, (ii) acts of God, acts of Customer, or acts of civil or military authorities, (iii) inability of Alcoil to obtain necessary labor, materials, components, or facilities, or (iv) any other commercial impracticability. In the event of any such delay, the date of delivery shall be deferred for a period of time equal to the time lost by reason of the delay.

LIMITED WARRANTY OF PRODUCTS AND SERVICES

Limited Warranty. Alcoil warrants its products to be free from defects in materials and workmanship under normal use and operation for a period of one (1) year from the date of product installation and no more than one (1) year and six (6) months from date of product delivery, as evidenced by Alcoil shipping records (the "Warranty Period"). For any materials or workmanship determined by Alcoil to be defective within the Warranty Period, Alcoil shall, at its option, either: (i) repair any such defective material, component part, or service, or (ii) make available to Customer, FOB York, Pennsylvania, any repaired or replacement parts or materials to replace such defective material, component part, or service, or (iii) refund to Customer the amount paid by Customer for the defective product or service provided by Alcoil hereunder.

Exclusions. The above warranty shall not apply to any product that has been: (i) subjected to misuse, negligence or accident; (ii) misapplied by Customer or others for an improper use; (iii) installed in an improper manner; (iv) modified or repaired contrary to Alcoil recommendations or generally accepted practices or procedures in the industry, or (v) operated under conditions which may cause product failure. Alcoil shall not be responsible for any costs associated with the product damage, loss or replacement due to freeze-up, improper water treatment, improper cleaning, fluid chemistry exceeding Alcoil's recommendations, clogging and debris, fouling, corrosion, galvanic induced corrosion, vibration, thermal cycling, hydraulic shock, over-pressurization, compressor failure, system contamination, loss of protective coating (where applied) and any other operating or system condition which may cause product failure.

Warranty Procedures. If any Alcoil product is believed to be defective, written notice of such warranty claim must be made and an RMA# (Return Authorization) must be issued by Alcoil, 3627 Sandhurst Dr, York, PA 17406. Ph: 717-347-7500 Alcoil, at its option, may require return of any product believed to be defective for purposes of testing, inspection and verification, as a requirement for potential warranty coverage.

Disclaimer of Further Warranties. THE LIMITED WARRANTY SET FORTH ABOVE IS THE EXCLUSIVE WARRANTY APPLICABLE TO THIS CONTRACT, AND ALCOIL EXPRESSLY DISCLAIMS ALL OTHER WARRANTIES OR REMEDIES, INCLUDING WARRANTIES OF MERCHANTABILITY AND FITNESS FOR A PARTICULAR PURPOSE, WHETHER THE SAME ARE WRITTEN, VERBAL, IMPLIED, OR STATUTORY.

Limitation of Liability. Under no circumstances shall Alcoil be liable for any incidental, consequential, or special damages, losses, or expenses incurred by Customer or any third party arising from this offer of sale or the performance of Alcoil hereunder. Under no circumstances shall the amount of any claim for damages or liability exceed the amount paid by Customer for products and services provided by Alcoil hereunder.

Time Limitation on Warranty Claims. No legal action or claim, whether based in tort, contract, strict liability, breach of warranty or otherwise, arising out of this offer of sale or the performance by Alcoil hereunder may be commenced more than one (1) year following expiration of the Warranty Period. Customer hereby waives any such claim or cause of action commenced after the Warranty Period.

TAXES AND DUTIES. Customer shall be responsible for collection or payment of any federal, state, provincial or local taxes or duties. Any taxes which Alcoil may be required to pay or collect, under any existing or future law, with respect to the sale, purchase, delivery, storage, or use of any product or services covered hereunder shall be the responsibility of Customer.

PROPRIETARY RIGHTS

Alcoil retains the exclusive right to all trade names, service marks, trademarks and patents for which Alcoil is the lawful owner or Licensee, and Customer acknowledges that Customer acquires no right, title or interest in or to any such trade names, service marks, trademarks or patents for any reason.

JURISDICTION AND VENUE. As to litigation arising from any disputes, claims or controversy, both Customer and Alcoil: (i) submit to the exclusive general jurisdiction of the state courts of York County, Pennsylvania, the federal courts of the United States of America for the Middle District of Pennsylvania, and any appellate courts from any decision thereof; (ii) consent that any such action or proceeding may be brought in such courts; and (iii) waive any objection that either may have to the venue of any such action or proceeding in any such court or that such action or proceeding was brought in an inconvenient forum and each party agrees not to plead or claim the same.

ENTIRE AGREEMENT. These terms constitute the entire agreement between the parties and all prior negotiations and representations of the parties are merged herein.

PENNSYLVANIA LAW TO APPLY. Any purchase order, shipment or contract resulting from Customer's acceptance of this offer of sale shall be deemed to have been executed and delivered in York County, Pennsylvania, and shall be construed under, and in accordance with, the laws of the Commonwealth of Pennsylvania.

WAIVER. One or more waivers of any breach of any term or condition herein shall not be construed as a waiver of any subsequent breach of the same term or condition. To be effective, any express waiver must be in writing.

COLLECTION COSTS. Should Customer default in the payment of any amount owing to Alcoil for products or services, and Alcoil is required to expend costs and expenses in collecting such amount, Alcoil shall be entitled to reimbursement for all such costs of collection (including reasonable attorney fees).

PRODUCT SELECTION AND USE. Customer shall be responsible for accurate design and operating conditions used in the selection and use of Alcoil products. Customer selection and use of Alcoil product from published literature or Alcoil Selection software shall be at the customer's risk as to appropriate application, design conditions and performance criteria use.

STANDARDS AND TOLERANCES. All Product Dimensions and published information is subject to change without notice. All Alcoil products furnished to Customer shall also be subject to tolerances and variations consistent with usages of the trade concerning dimensions, composition and mechanical properties, and normal variations in performance characteristics and quality.

SPECIAL ORDERS. On special orders and products of custom design, a minimum of 50% of the sale price may be required upon engineering approval by the customer.

RESTOCKING AND CANCELLATION CHARGES. Alcoil reserves the right to collect costs against returned product and cancelled orders. Restocking charges of returned product costs shall be 25% of the product(s) sales price, and cancellation charges shall be a minimum of 25% of the product(s) sales price, or work in progress costs incurred by Alcoil, whichever is higher.

MicroChannel Coil Family

Alcoil has a full line of MicroChannel coil models for cooling and heat rejection for HVAC/R systems for R410a, R134a, R404a,, R717, and other refrigerants. Water and Glycol fluid models are available as both cooling coils and heating coils. Model sizes as small as 3"x 3" to 80" x 144" size.

Condensers

½ to 40 tons

Alcoil manufactures a full range of refrigerant condensers from ½ ton to 40 tons for the HVAC/R industry, rated for 450 psig and 650 psig applications. The C Series Condenser is a robust design with built-in mini-receiver and numerous design options.



Evaporator/Heat Pump

½ to 30 tons

Alcoil's E Series Evaporator and HP Series Heat Pump represent leading edge technology as a direct expansion (DX) cooling coil and/or reverse cycle heat pump coil. With a built-in refrigerant distributor and integrally high water condensate shedding, the E and HP Series provide high performance with all the advantages of MicroChannel technology.

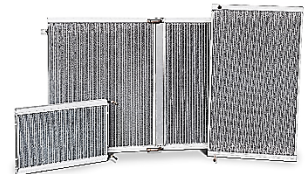

Fluid Coils

up to 50 gpm

For water and glycol systems, free cooling, heat recovery and other applications, Alcoil manufactures a high performance microchannel specifically for fluid to air. With advanced water shedding as a cooling coil or high performance as a heating or cooling coil, fluid models feature ¾", 1" and 1-1/2" connections. Rated for 300psig.



Specialty Coils

up to 40 tons

Alcoil can configure microchannel coils for other required HVAC/R applications, including:

- Reheat & Desuperheater Coils
- Flooded & Pumped Loop Evaporators.
- Subcoolers

MicroCoils™

up to ¾ ton

For electronics, medical, computer and small appliance products, Alcoil has a family of MicroCoils™ as condensers, evaporators and fluid coils. The MicroCoil™ is lightweight and ultra small for specialty products from 20 to 2000 watts.



Alcoil products manufactured under Patent 8,662,148 and others pending in the U.S., Patents pending in Europe, China and other countries



Alcoil Sales Support

Alcoil serves the U.S., Canada and Mexico with regional Sales Engineers, Applications Engineers and HDQ personnel to assist OEM customers with product selection, applications, and production delivery.

Shipping is via Freight Carriers or UPS. Freight Pre-paid or Freight Collect.

All Prices are FOB, York, Pennsylvania, USA

General Inquiries Email: Info@Alcoil.net

Production Lead-times 4 weeks typical;
up to 6 weeks (seasonal)
up to 6 weeks (large qty)

Purchase Orders Email to: Orders@Alcoil.net

Expedited Orders Contact your regional Sales Engineer or Alcoil Factory



Alcoil is leading manufacturer of Airside Microchannel Coils for the HVAC/R and process industries. Located in beautiful York, Pennsylvania, Alcoil employees take Pride in Workmanship, Quality and Customer Service. We sincerely appreciate the opportunity for Alcoil to be of service.

www.Alcoil.net

Alcoil
3627 Sandhurst Drive
York, PA 17406
Ph: 717-347-7500
Fax: 717-347-7383

